

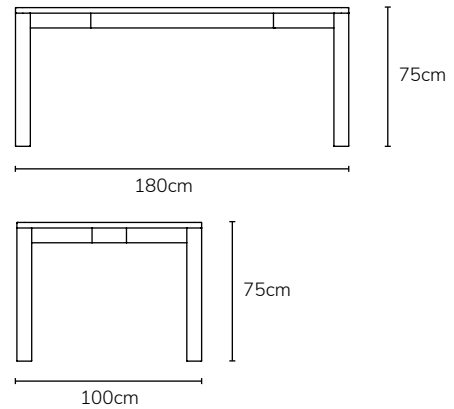

**ICON BY
DESIGN**

Otto - Rectangle Dining Table

Available America Oak & Walnut



- Contemporary Design
- Fine lines and clean angles
- Stunning curved joinery feature

- Solid Timber Construction
- Stronger, heavier and of a much higher quality than veneered wood or MDF
- Assembly required

IMAGE	DIMENSIONS	PRODUCT DESCRIPTION	CODE OAK	CODE WALNUT
	W140 x D80 x H75cm	Otto Rectangle Dining Table 140 x 80cm	OS1055	
	W160 x D90 x H75cm	Otto Rectangle Dining Table 160 x 90cm	OS1054	
	W180 x D100 x H75cm	Otto Rectangle Dining Table 180 x 100cm	OS1004	OS1005
	W200 x D110 x H75cm	Otto Rectangle Dining Table 200 x 110cm	OS1006	
	W240 x D110 x H75cm	Otto Rectangle Dining Table 240 x 110cm	OS1008	
	W280 x D110 x H75cm	Otto Rectangle Dining Table 280 x 110cm	OS1010	

This table has a highly durable, clear lacquer, satin finish. It is designed to be hard wearing. However, all lacquer finishes may be susceptible to water damage if the water is left on the table for long periods, especially if the water is very hot. We recommend the use of coasters or table mats if spillage is an inevitable issue. If the table is wiped off after each use, it can be safely used without any coverings



**ICON BY
DESIGN**

Otto - Chair Placement Configuration

HENRIK

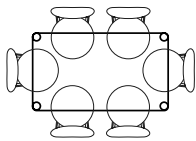

Otto 140 x 80
Comfortable x 4

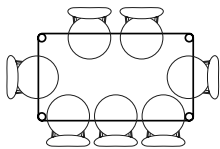

Otto 160 x 90
Comfortable x 6
Cosy x 8

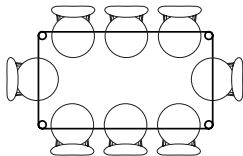

Otto 180 x 100
Comfortable x 8

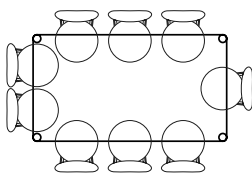

Otto 200 x 110
Comfortable x 8
Cosy x 10

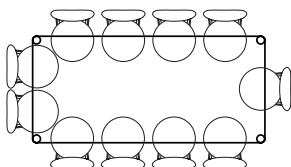

Otto 240 x 110
Comfortable x 10
Cosy x 12

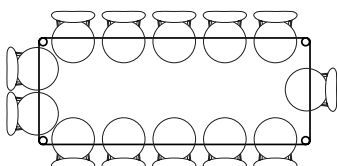

Otto 280 x 110
Comfortable x 12
Cosy x 14

ASTRID, NESTOR, STEFAN

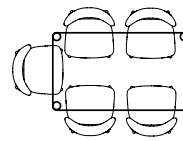

Otto 140 x 80
Comfortable x 4
Cosy x 6

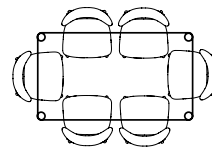

Otto 160 x 90
Comfortable x 6

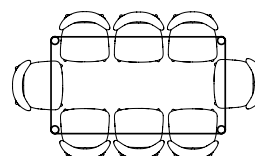

Otto 180 x 100
Cosy x 8

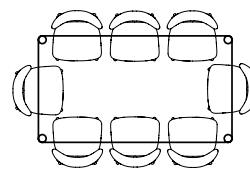

Otto 200 x 110
Comfortable x 8

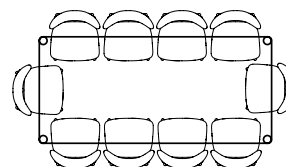

Otto 240 x 110
Cosy x 10

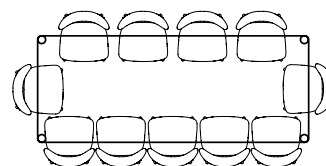

Otto 280 x 110
Comfortable x 10
Cosy x 12