

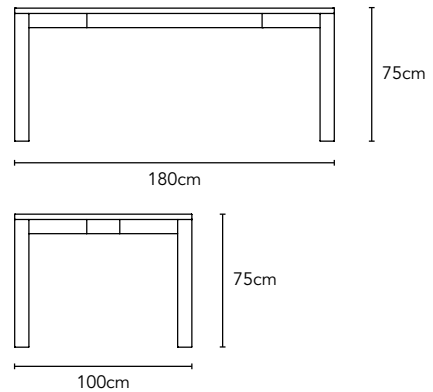

**ICON BY  
DESIGN™**

## Otto - Dining Table

Available in American Oak & American Walnut



- Contemporary Design
- Fine lines and clean angles
- Stunning curved joinery feature
- Solid Timber Construction
- Stronger, heavier and of a much higher quality than veneered wood or MDF
- Assembly required

IMAGE	DIMENSIONS	PRODUCT DESCRIPTION	CODE OAK	CODE WALNUT
	W140 x D80 x H75cm	Otto Rectangle Dining Table 140 x 80cm	OS1055	
	W160 x D90 x H75cm	Otto Rectangle Dining Table 160 x 90cm	OS1054	
	W180 x D100 x H75cm	Otto Rectangle Dining Table 180 x 100cm	OS1004	OS1005
	W200 x D110 x H75cm	Otto Rectangle Dining Table 200 x 110cm	OS1006	
	W240 x D110 x H75cm	Otto Rectangle Dining Table 240 x 110cm	OS1008	
	W280 x D110 x H75cm	Otto Rectangle Dining Table 280 x 110cm	OS1010	

This table has a highly durable, clear lacquer, satin finish. It is designed to be hard wearing. However, all lacquer finishes may be susceptible to water damage if the water is left on the table for long periods, especially if the water is very hot. We recommend the use of coasters or table mats if spillage is an inevitable issue. If the table is wiped off after each use, it can be safely used without any coverings.



**ICON BY  
DESIGN™**

---

## Otto - Chair Placement Configuration

---

### HENRIK

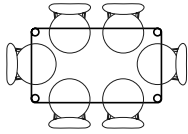

**Otto 140 x 80**  
Comfortable x 4

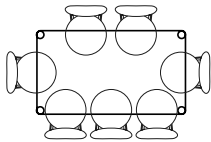

**Otto 160 x 90**  
Comfortable x 6  
Cosy x 8

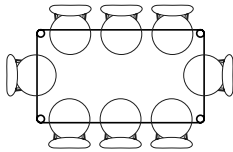

**Otto 180 x 100**  
Comfortable x 8

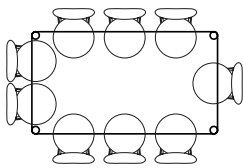

**Otto 200 x 110**  
Comfortable x 8  
Cosy x 10

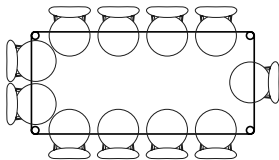

**Otto 240 x 110**  
Comfortable x 10  
Cosy x 12

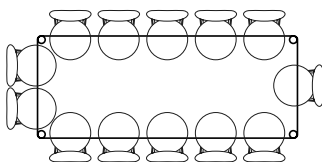

**Otto 280 x 110**  
Comfortable x 12  
Cosy x 14

### ASTRID, NESTOR, STEFAN

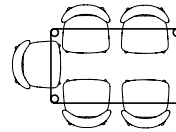

**Otto 140 x 80**  
Comfortable x 4  
Cosy x 6

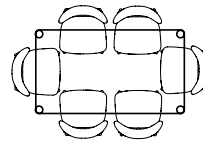

**Otto 160 x 90**  
Comfortable x 6

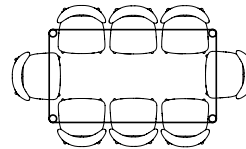

**Otto 180 x 100**  
Cosy x 8

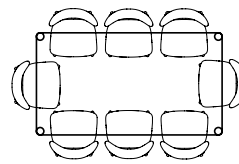

**Otto 200 x 110**  
Comfortable x 8

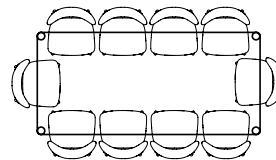

**Otto 240 x 110**  
Cosy x 10

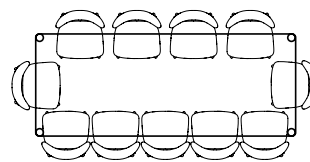

**Otto 280 x 110**  
Comfortable x 10  
Cosy x 12



**ICON BY  
DESIGN™**

---

## Otto - Bench Placement Configuration

---

### OTTO OAK BENCH OPTIONS

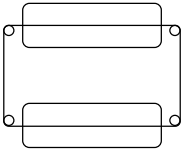

**Otto 140 x 80**  
Otto 110 (x2)

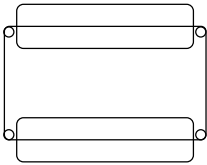

**Otto 160 x 90**  
Otto 140 (x2)

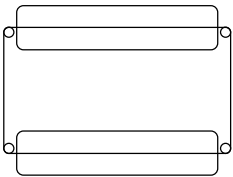

**Otto 180 x 100**  
Otto 160 (x2)

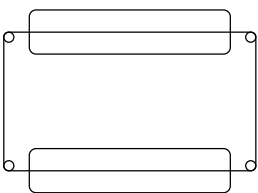

**Otto 200 x 110**  
Otto 160 (x2)

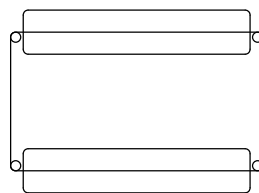

**Otto 200 x 110**  
Otto 180 (x2)

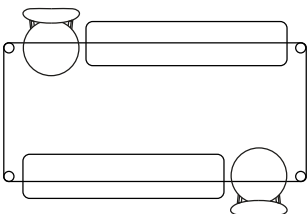

**Otto 240 x 110**  
Otto 160 (x2)

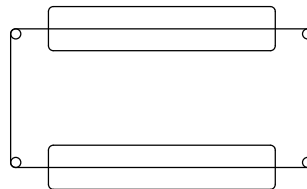

**Otto 240 x 110**  
Otto 180 (x2)

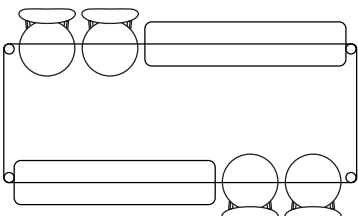

**Otto 280 x 110**  
Otto 160 (x2)

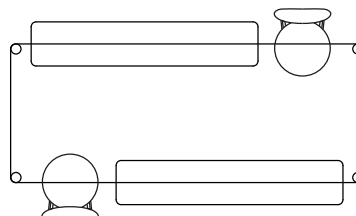

**Otto 280 x 110**  
Otto 180 (x2)



**ICON BY  
DESIGN™**

---

## Otto - Bench Placement Configuration

---

### MAGNUS OAK BENCH OPTIONS

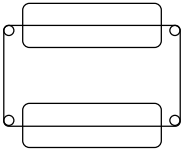

**Otto 140 x 80**  
Magnus 110 (x2)

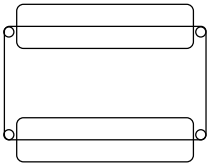

**Otto 160 x 90**  
Magnus 140 (x2)

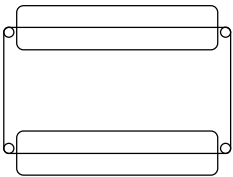

**Otto 180 x 100**  
Magnus 160 (x2)

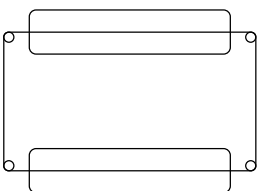

**Otto 200 x 110**  
Magnus 160 (x2)

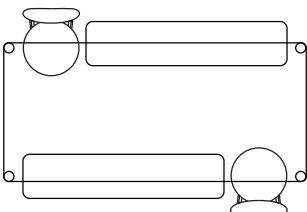

**Otto 240 x 110**  
Magnus 160 (x2)

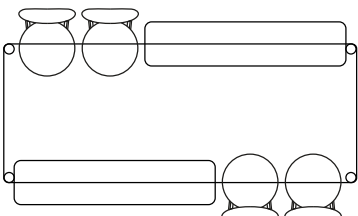

**Otto 280 x 110**  
Magnus 160 (x2)

### MAYA OAK BENCH OPTIONS

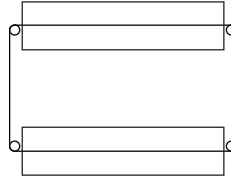

**Otto 180 x 100**  
Maya 160 (x2)

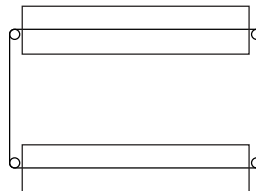

**Otto 200 x 110**  
Maya 180 (x2)

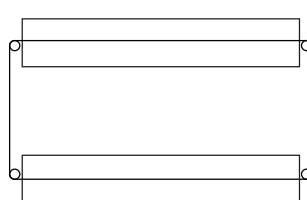

**Otto 240 x 110**  
Maya 220 (x2)

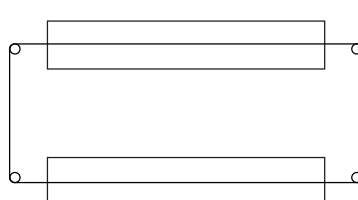

**Otto 280 x 110**  
Maya 220 (x2)